

# indoor and outdoor entrance mats

**GRIDIRON®**  
GRIGLIATI TECNICI

**GRIDIRON®**  
SPECIAL PRODUCTS

# index

GRIDIRON DOORMATS, PRACTICAL AND STYLISH	page	4
USEFUL INSTRUCTIONS	page	6
CUSTOMISABLE GRIDIRON DOORMATS	page	8
INDOOR ENTRANCE MATS	page	10
HEAVY DUTY DOORMATS FOR PARTICULAR REQUIREMENTS	page	18
OUTDOOR ENTRANCE MATS	page	24
RUBBER ENTRANCE MATS	page	32
INSTALLATION ACCESSORIES	page	42
CLEANING AND MAINTENANCE	page	44
FINISHES	page	45



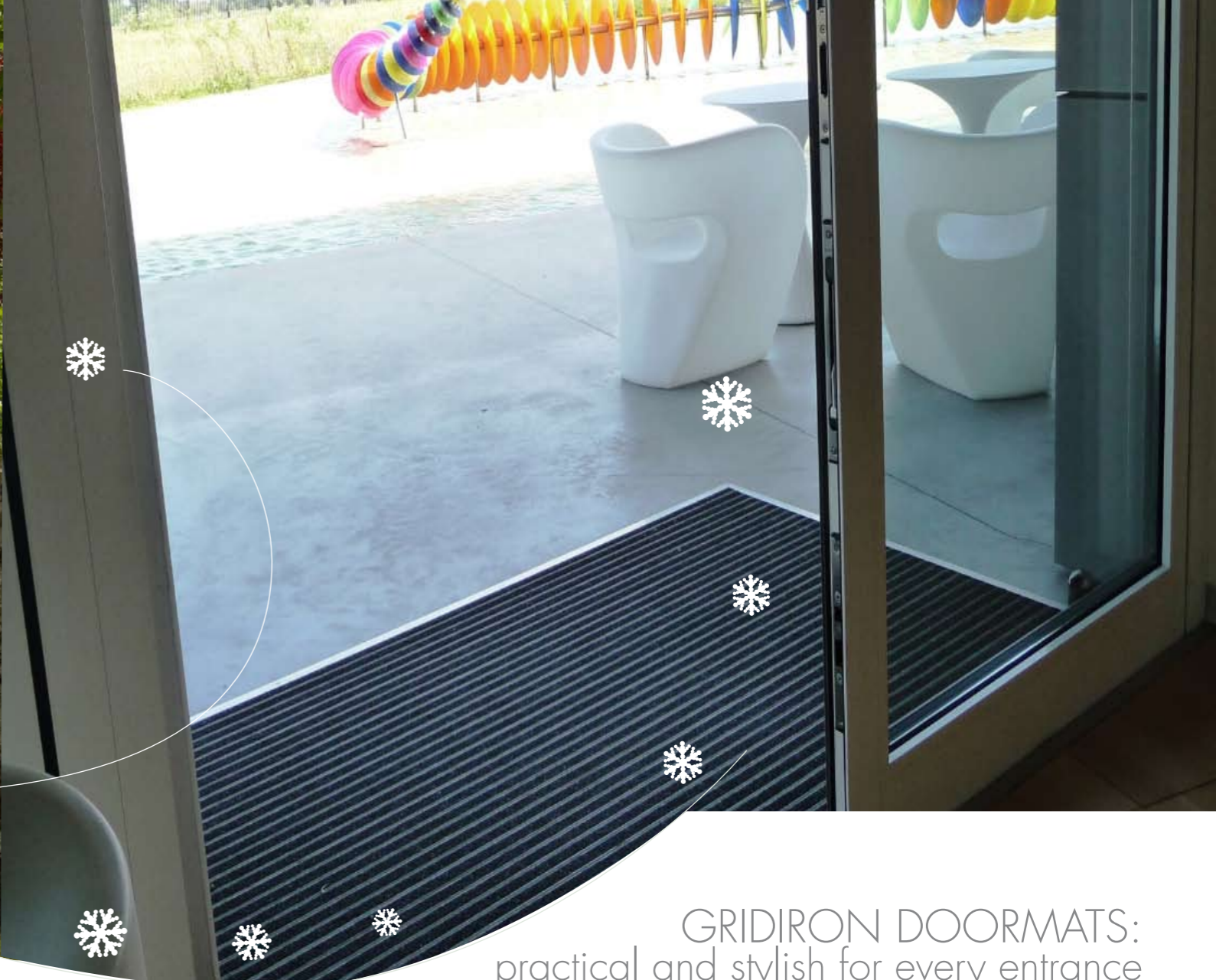

## GRIDIRON DOORMATS: practical and stylish for every entrance

**Gridiron has focused on a range of customisable doormats with extraordinary robustness and functionality.**

Particular attention was placed on the aesthetic aspects of Gridiron's doormats, in addition to their functionality, making them true furnishing accessories that give a special touch to your spaces. Doormats are subject to wear; they must therefore be able to effectively perform their functions over time of retraining dirt and absorbing moisture, which are characteristics that require high quality workmanship.

Standard and customisable doormats make it possible for designers to create characteristic and architecturally exclusive design environments. Designed for internal entrances, the various doormat models are easy to clean and meet the needs of "cleaning and protection" as well as a pleasant aesthetic addition to a wide range of varying situations. Their characteristics are also guaranteed in high-traffic areas.







1

## IDEAL SOLUTION

- a) Outdoor area for dirt and dampness collection (see page 23)
- b) Middle area for collecting dirt and moisture (see page 16)
- c) Inner area for general cleaning

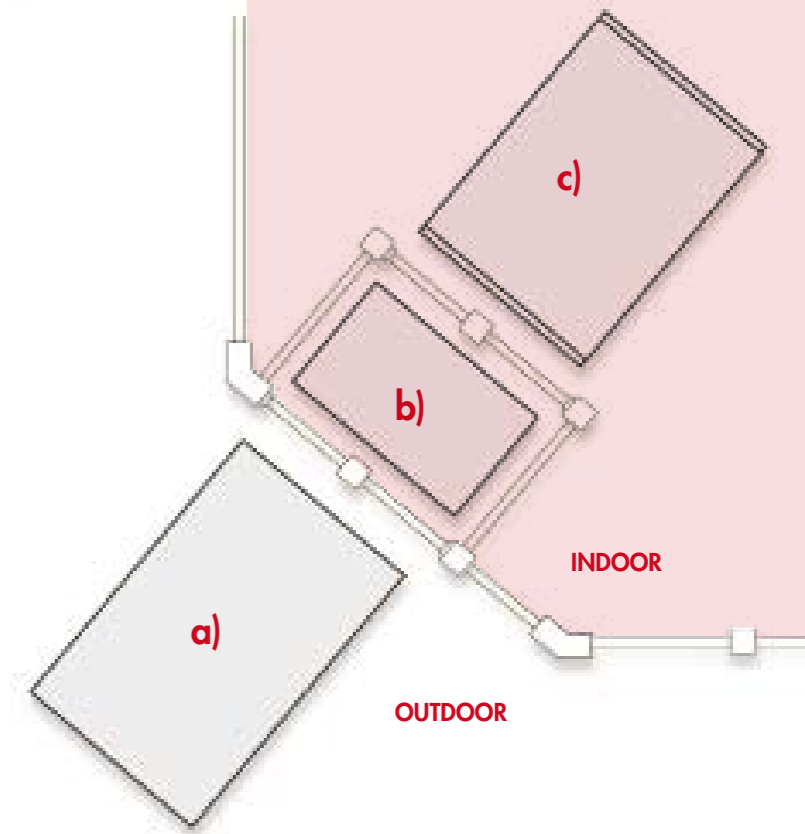

## USEFUL NOTES

When designing a Top Clean doormat, the following points should be considered:

- **Best efficiency:** the doormat should always be fitted in a frame flush with the floor. Sizes and fitting of the frame are described in the section "Installation accessories".
- **Top Clean Trend doormats:** when ordering, always indicate the length of the strips and the walking direction (see figure 2).
- **Supply of frame and doormat:** when ordering a frame and doormat system, please indicate the outside dimension of the frame. From this dimension we take off about 10 mm for the final dimension of the doormat.

### Example:

Measurements - doormat only 1090x690

Measurements - frame exterior 1100x700

"Well" measurement for in-floor installation 1110x710

As you can see, the well is 1cm larger in comparison to a frame measurement.

Once installed, a 5mm space will remain between the floor and the frame that can be filled with concrete grout.

Furthermore, the thickness of the frame, (3mm in almost all cases) in comparison to the bottom of the well, once installed will have a 3 mm difference in level that must be compensated for using self-levelling mortar. This passage makes the doormat resting surface flat and levelled.

- **Frame already in place:** when a frame is already fitted, indicate its inner dimensions. From this dimension we take off about 10 mm for the final dimension of the doormat.

- **Water drainage:** when installing frames outdoors, it will be necessary to install a water outlet for drainage (for instance, by making an opening in the floor).

- **Heavy-duty:** for entrance areas with heavy foot traffic such as at airports, supermarkets, shopping centres etc. we recommend our Top Clean Stabil doormats which can fully withstand the wear.

- **Custom made production:** for custom made items, we advise a special template in PVC, which is not sensitive to atmospheric agents and keeps its exact dimensions.

**Attention:** do not fold the template, just roll it. The upper part of the template and the walking direction are to be shown. Only by receiving exact data can a tailor-made doormat be produced.

2

## Some examples of correct and incorrect divisions

- a) Strip lengths
- b) Walking directions

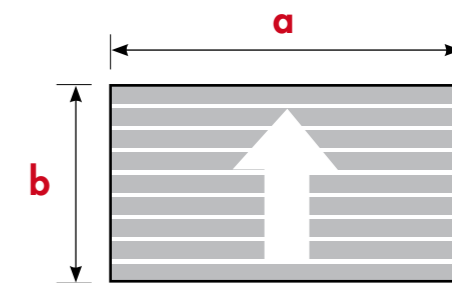

A CORRECT

B INCORRECT

c split along the length of the strip

d split in the walking direction

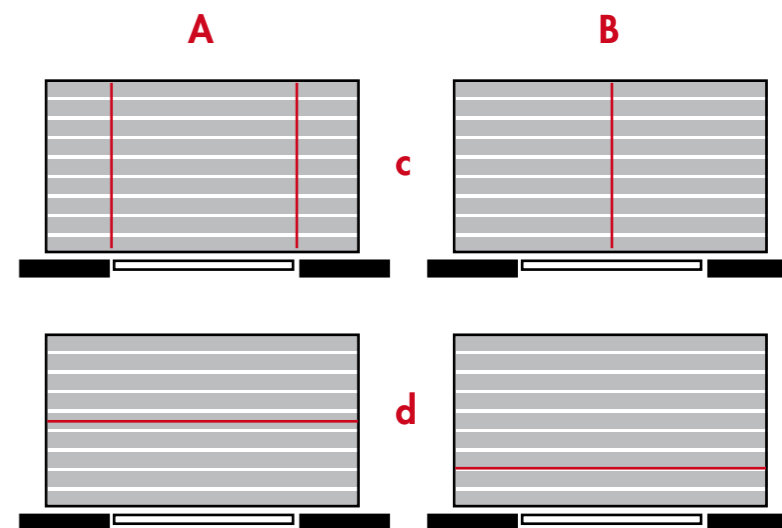

The manufacturer recommends, if possible, splitting the doormat in the walking direction.

3

The red lines correspond to the surcharge for the cut-outs in the doormats or frames.





# Always in pole position for ORIGINALITY and QUALITY

CUSTOMISABLE GRIDIRON DOORMATS FOR EXCLUSIVE RESULTS

**Gridiron, number one in doormat customisation.** Particular shapes can be created, also with the insertion of alternating coloured strips, all completed by a wide variety of ribbed carpet, brushes and rubbers. This makes it possible for designers to implement an original design.

**Number one in guaranteeing high quality.** Gridiron doormats are resistant to the frequent passage of mobility wheeled traffic and pedestrians, assuring their duration over time. They are also easy to install and take care of.

**Number one in design.** The insertion of distinctive decorative elements that are in line with the customer's corporate identity becomes an element that is integrated and coordinated with the architecture of the spaces where the doormats will be positioned.

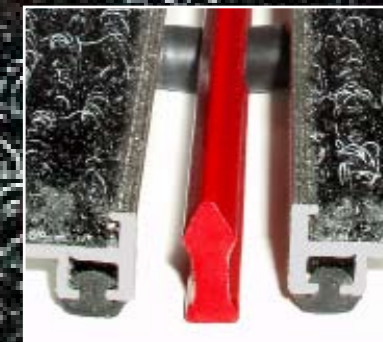
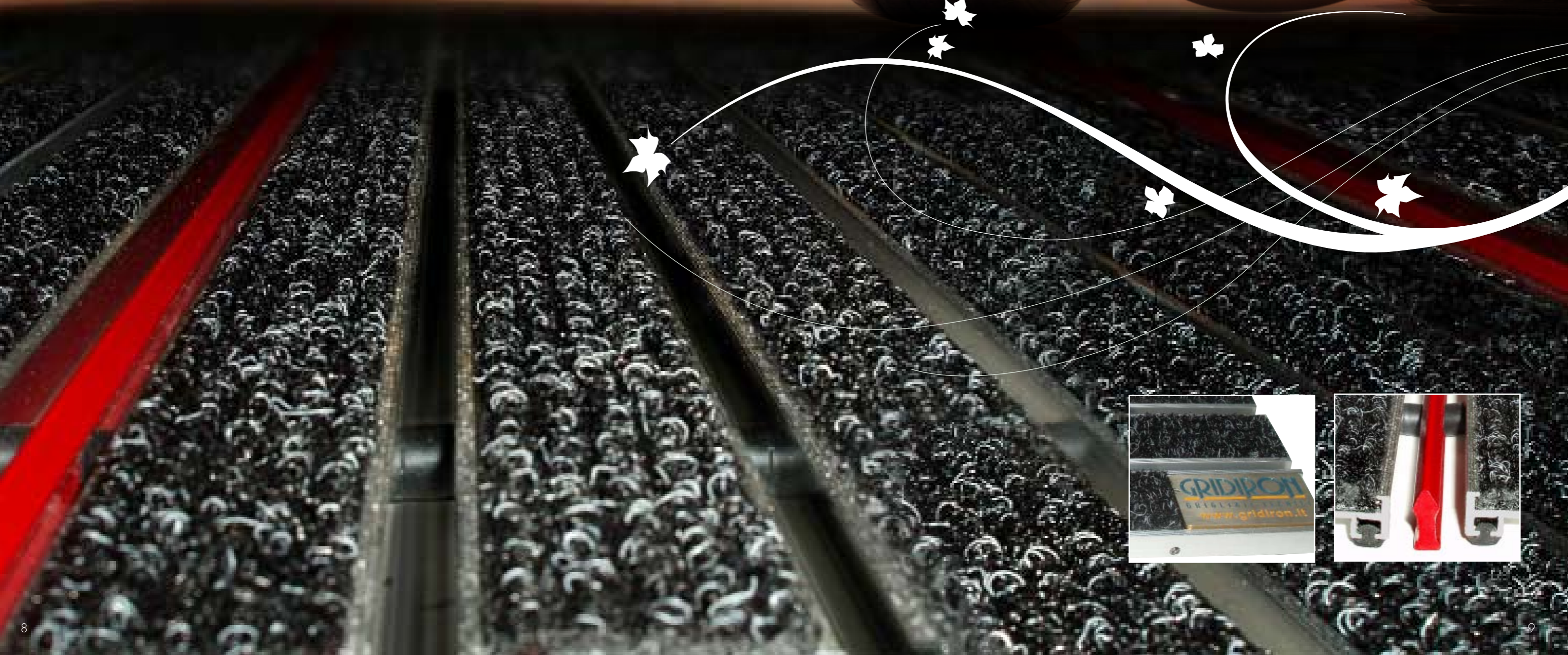
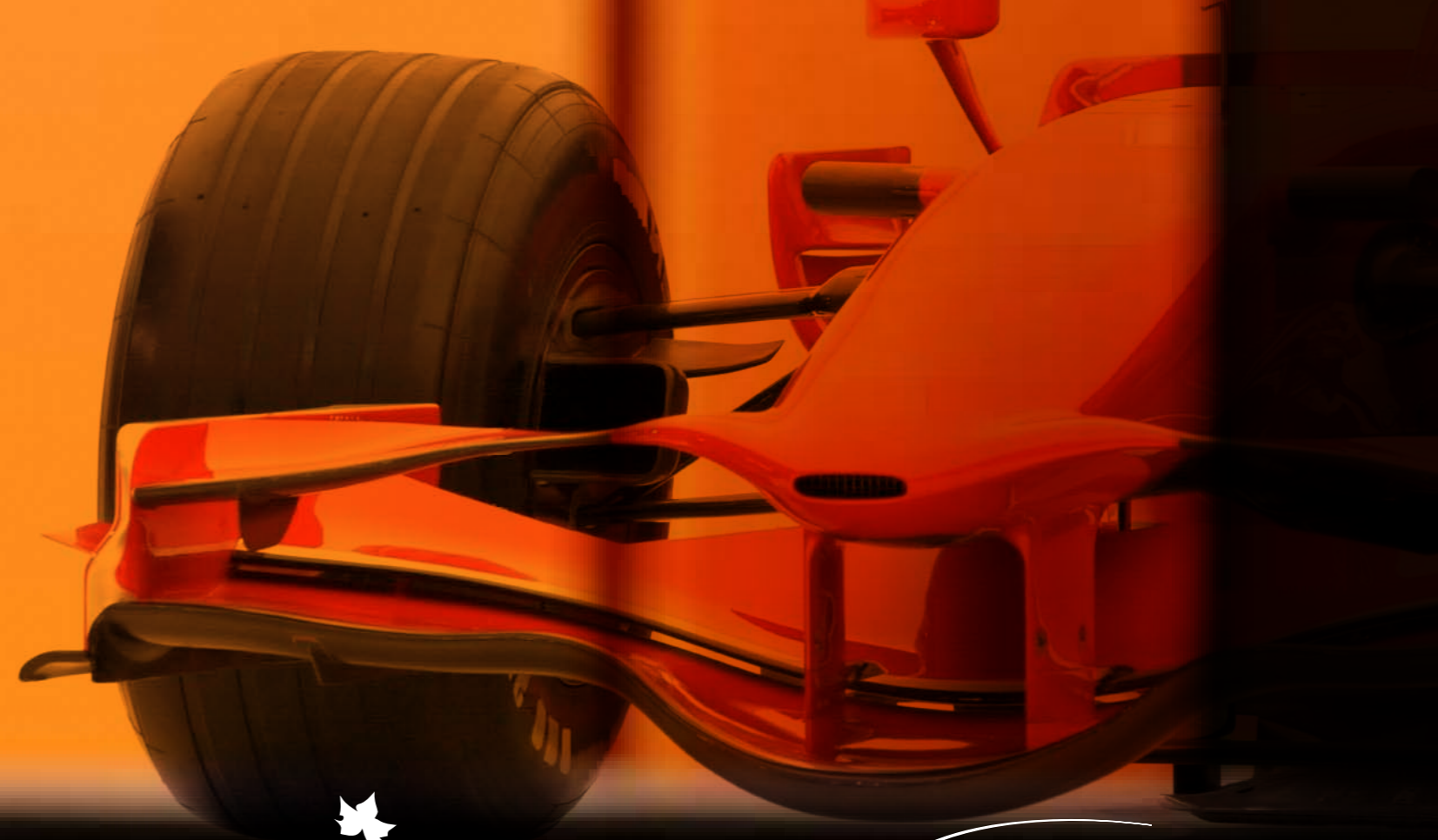





## DOORMATS FOR INDOOR ENTRANCES

Always seeking the best products for the most attentive customers, a highly qualified team at Gridiron has selected a high quality product for you: Gridiron indoor doormats, the ideal solution for giving a classy touch to every type of entrance. The variety and high quality of the materials means that we can fulfil the widest range of requests, both for residential and industrial uses. The enormous extent of combinations means that you can choose an entrance mat that is not only guaranteed to be practical and long-lasting, but also assures the best styling. Each product comes supplied with a kit of accessories for its easy and immediate fitting.

- **TOP CLEAN LIGHT EXTRA - DOORMATS WITH RIBBED CARPET**
- **TOP CLEAN TREND® - DOORMATS WITH RIBBED CARPET**
- **TOP CLEAN TREND® - DOORMATS WITH RIBBED CARPET AND BRUSH STRIPS**







### TOP CLEAN LIGHT EXTRA DOORMATS WITH RIBBED CARPET

Doormat suited to indoor and covered entrances. High cleaning power. Holds the dirt and absorbs dampness. Total height: only 10 mm, which corresponds to about the same height as the tiles. Perfect for laying on top of floors where there is no need for a frame. Suitable for entrances with a normal frequency of foot traffic. Easy to roll up and clean.

#### Characteristics

- Aluminium non-twisting strip for laying on top of floors
- The elements are linked together by a section in perforated rubber
- Ribbed Carpet: 100% resistant to UV light, in very strong polypropylene
- Weight composition of the ribbed carpet: 900 g/m<sup>2</sup>, total weight: approx. 1,250 g/m<sup>2</sup>
- Underside of doormat: the rubber strips make walking on the doormat quieter
- Strip height: 10 mm
- Distance between strips: 5 mm (rubber coated connecting wire)
- Dimensions: Tailor made to any measure required: in width (length of strips) and depth (walking direction).  
For installing in the frame, the walking direction is obtained with a shim strip if necessary. **Only rectangular and square Top Clean Light Extra mats are available, no cut-outs or shaping can be performed.**
- On request: powder coated aluminium strip in wide RAL colour range



#### Fine ribbed carpet colours



charcoal



pale grey



beige melange



blue melange



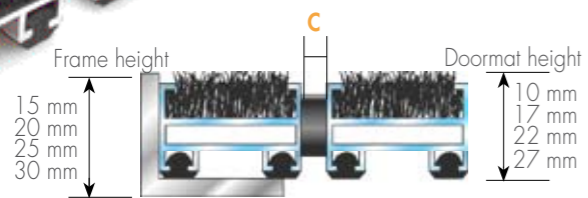
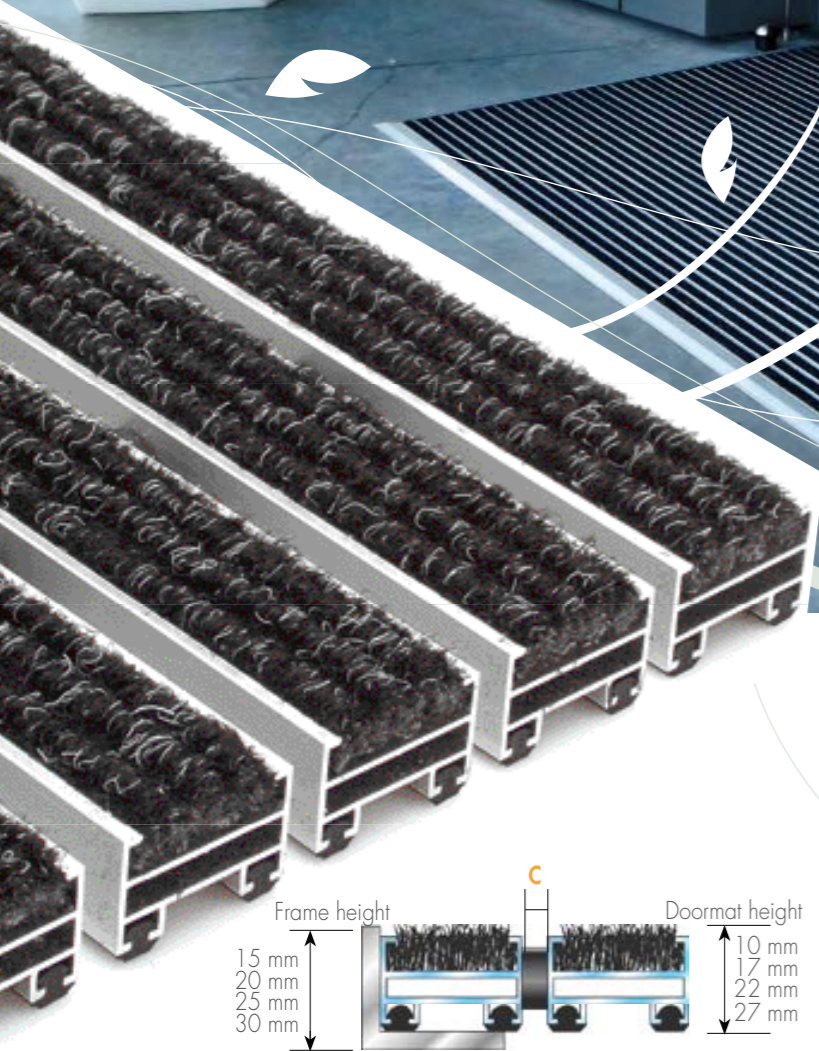

**TOP CLEAN TREND®**  
DOORMAT WITH RIBBED CARPET

Doormat suited to indoor and covered entrances. High cleaning and absorbing power. Holds the dirt and absorbs dampness. Also suitable for entrances with heavy frequency of traffic. Easy to roll up and clean.

**Characteristics**

- Aluminium non-twisting strip (approx. 1.5 mm thick)
- Connecting of the elements: steel flex with PVC sheath. Fixing: aluminium inserts with screws (AISI 316)
- Ribbed carpet: 100% resistant to UV light, in very strong polypropylene
- Weight composition of the ribbed carpet:  
Fine ribbed carpet 900 g/m<sup>2</sup>  
Total weight approx. 1,250 g/m<sup>2</sup> at h 10 mm  
Rough ribbed carpet 1,700 g/m<sup>2</sup>  
Total weight approx. 3,000 g/m<sup>2</sup> at 17, 22 and h 27 mm
- Underside of doormat: the rubber strips make walking on the doormat quieter
- Strip height: 10, 17, 22 and 27 mm
- NB: C) • for strip height 17, 22 and 27 mm, strip spacing 4 and 8 mm
- for strip height 10 mm, strip spacing 4 mm and not perforated (no inner chamber)
- Dimensions: Tailor made to any measure required. In width (length of strips) and depth (walking direction) without shimming strip. Cut-outs, angled or circular shaping can be performed to sketch or template, at a surcharge.
- On request: powder coated aluminium strip in wide RAL colour range

**Coarse type ribbed carpet colours for height 17,22,27 mm**

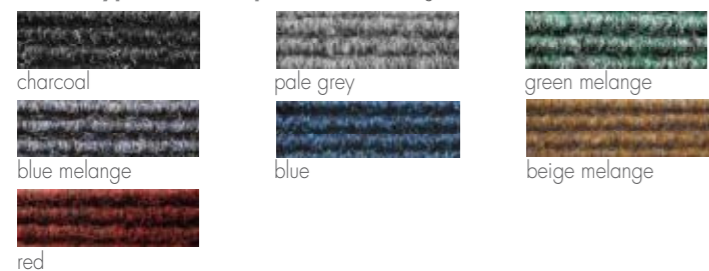

**Fine type ribbed carpet colours for height 10 mm**





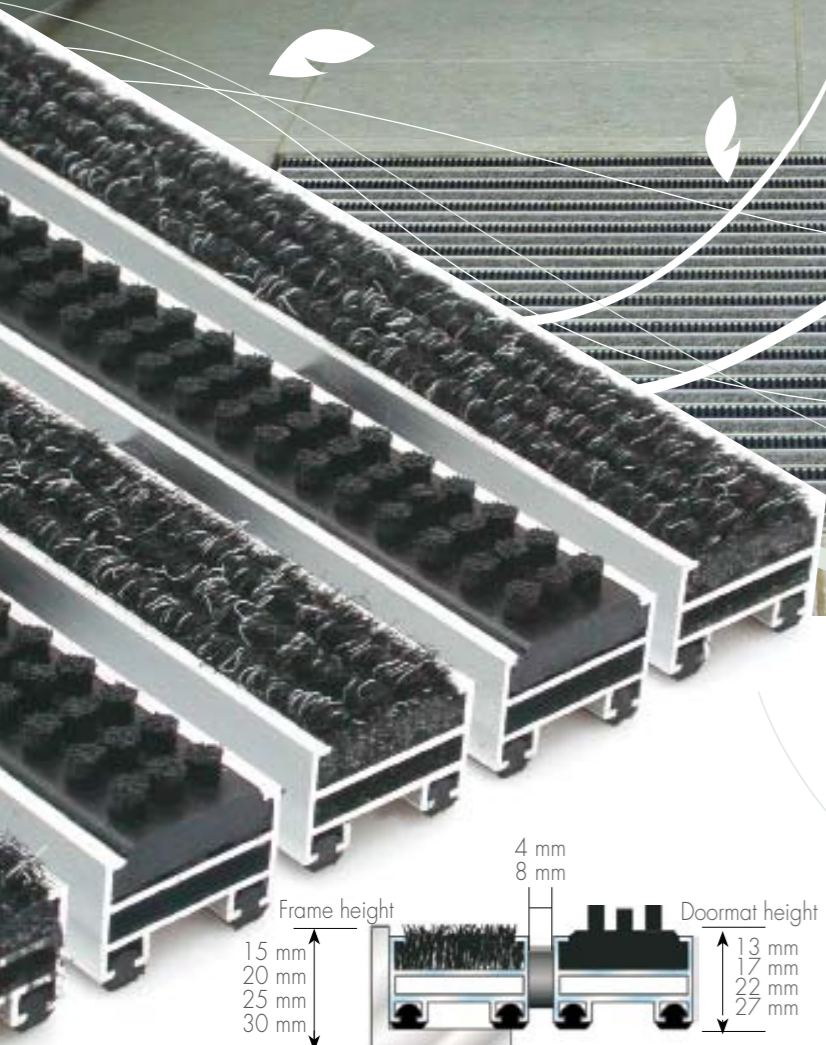
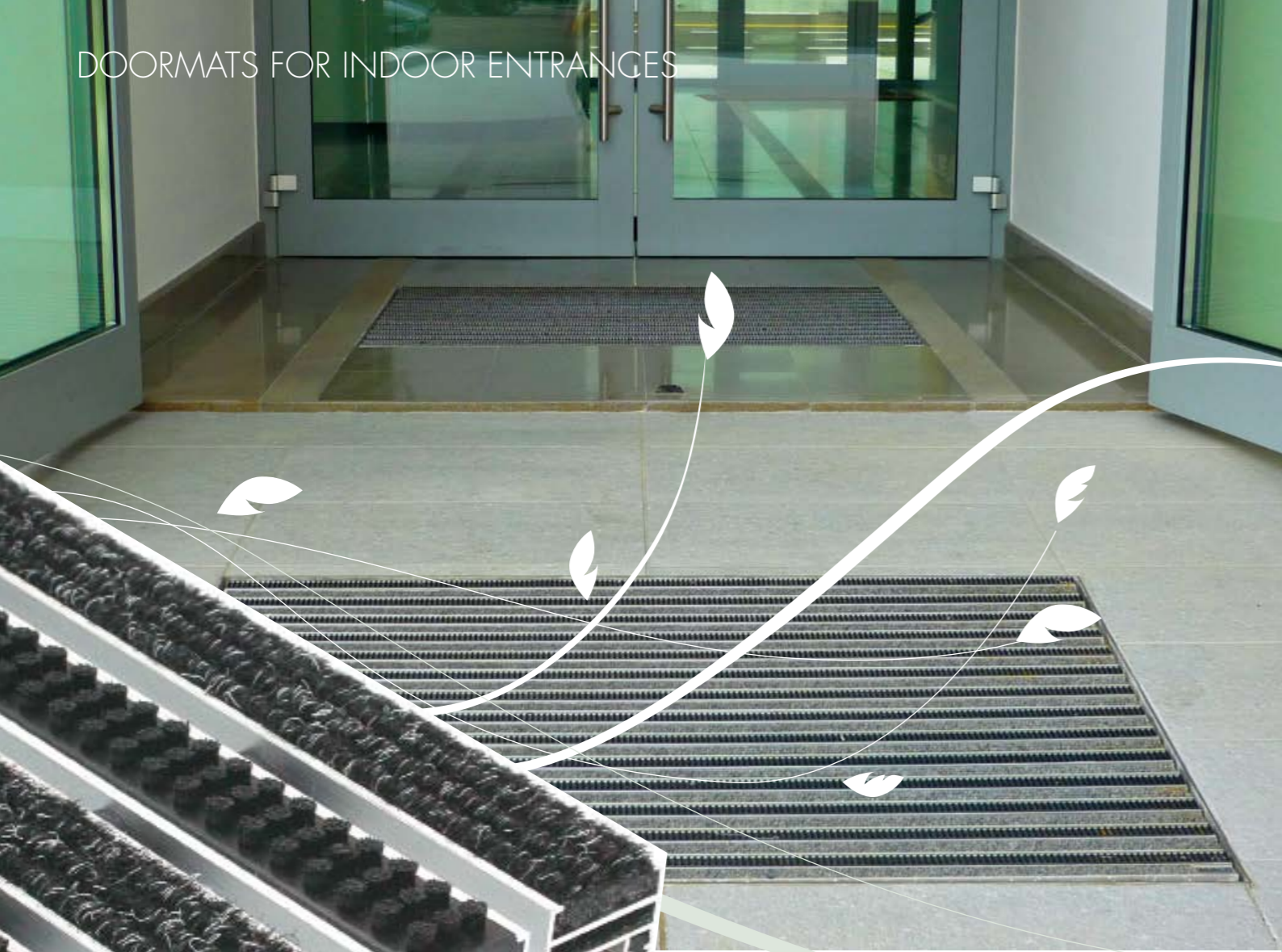

**TOP CLEAN TREND®**  
DOORMAT WITH RIBBED CARPET AND CASSETTE BRUSHES STRIPS

Doormat suited to indoor and covered entrances. High cleaning and absorbing power. Holds the dirt and absorbs dampness. Alternating ribbed carpet with cassette brushes strips ensures effective cleaning in the entrance area; particularly suitable for protecting valuable floorings such as marble, laminate or parquet. The cassette brushes strip is able to remove small stones and fine sand from the soles of shoes. Also suitable for entrances with heavy frequency of traffic. Easy to roll up and clean.

**Characteristics**

- Aluminium non-twisting strip (approx. 1,5 mm thick)
- Connecting of the elements: steel flex with PVC sheath. Fixing: aluminium inserts with screws (AISI 316)
- Ribbed carpet: 100% resistant to UV light, in very strong polypropylene
- Weight composition of the RIBBED CARPET:  
Rough ribbed carpet 1,700 g/m<sup>2</sup>  
Total weight approx. 3,000 g/m<sup>2</sup> at h 17, 22 and h 27 mm
- Sturdy cassette brushes strips in nylon 6.6 inserted in the non-twisting aluminium strip
- Underside of doormat: the rubber strips make walking on the doormat quieter
- Strip height: 17, 22 and 27 mm
- Distance between strips for 17, 22 and 27 mm: 4 and 8 mm (rubber spacer)  
Distance between strips for 13 mm: 4 mm only (rubber spacer)
- Dimensions: Tailor made to any measure required. In width (length of strips) and depth (walking direction) without shimming strip. Cut-outs, angled or circular shaping can be performed to sketch or template, at a surcharge.
- On request: powder coated aluminium strip in wide RAL colour range

**Ribbed carpet colours** for height 13,17,22,27 mm

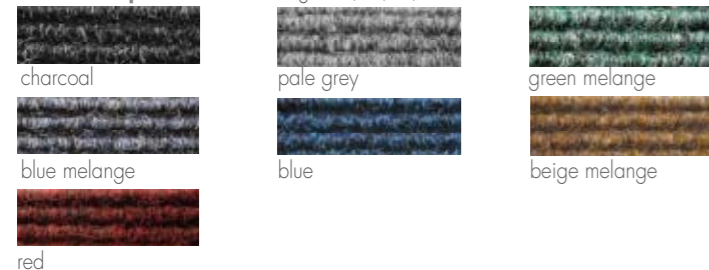

**Brush strips colours** for cassette height 13,17 mm

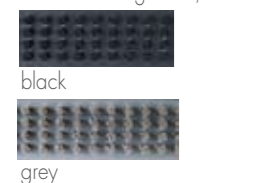

**Brush strips colours** for cassette height 22,27 mm

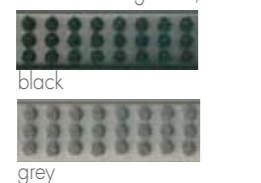





## HEAVY-DUTY DOORMATS FOR PARTICULAR REQUIREMENTS

In order to provide the best products for satisfying particular requirements, Gridiron offers high-quality, heavy-duty doormats that are resistant to the frequent passage of wheeled traffic and pedestrians, suitable for guaranteeing long duration over time. Easy to clean and robust, they are suitable for entrances with a high foot traffic. The vast amount of combinations makes it possible to select a doormat that, while being practical and hardwearing, will be the best aesthetic solution both for residential and industrial applications, such as railway-stations, airports, shopping centres, etc. Each product is supplied with an accessory kit for easy and immediate installation.

- **TOP CLEAN STABIL - DOORMATS FOR SPECIAL REQUIREMENTS**
- **TOP CLEAN OBJEKT® - EXTREME AND EXCEPTIONAL FOOT TRAFFIC**





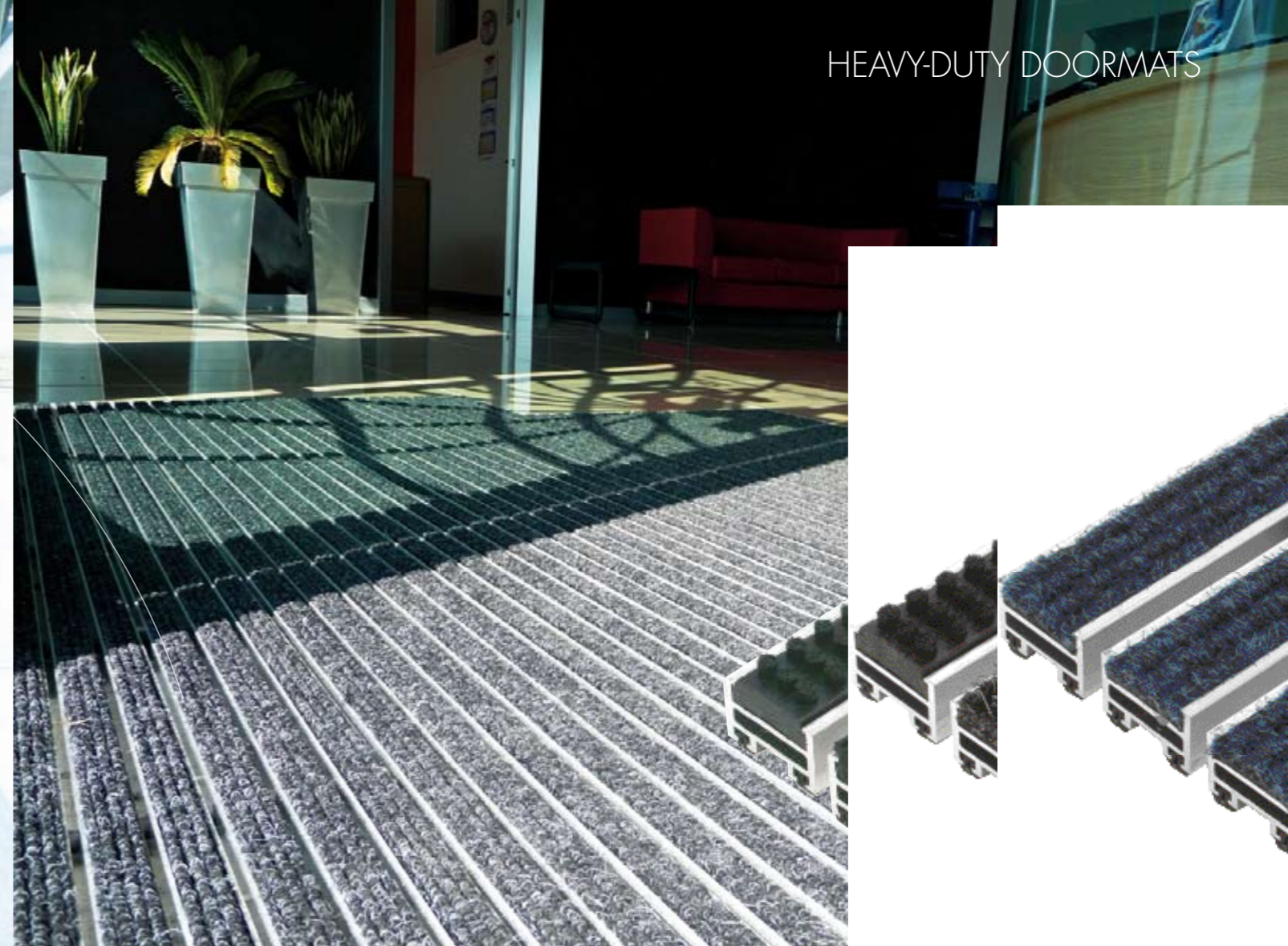

**TOP CLEAN STABIL**  
DOORMATS FOR SPECIAL REQUIREMENTS

Top Clean Stabil is the heavy duty version of Top Clean Trend and is specifically designed for areas of heavy foot traffic such as supermarkets, department stores or airport terminals. Sturdy, easy to roll up and clean.

Characteristics

- Aluminium non-twisting strip (2,5 mm thick)
- Connecting of the elements: steel flex with PVC sheath. Fixing: aluminium inserts with screws (AISI 316)
- Underside of doormat: rubber strips make walking on the doormat quieter
- Ribbed carpet weights: Rough ribbed carpet 1700 g/m<sup>2</sup>, total weight: ca. 3000g/m<sup>2</sup>
- Strip height: 17 and 22 mm
- Distance between strips: 4 mm (rubber spacer)
- Dimensions: Tailor made to any measure required. In width (length of strips) and depth (walking direction) without shimming strip. Cut-outs, angled or circular shaping can be performed to sketch or template, at a surcharge.
- On request: powder coated aluminium strip in wide RAL colour range

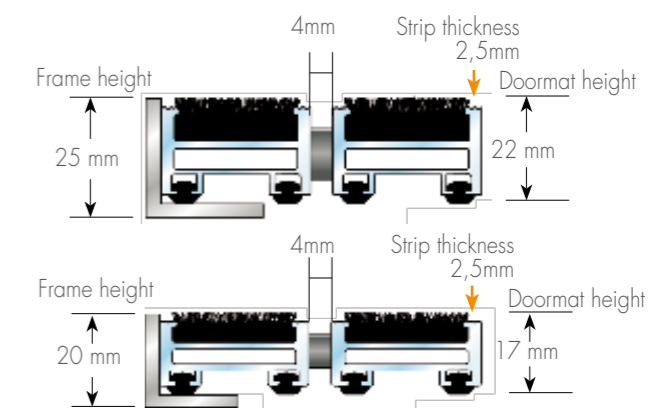

Fabric colours

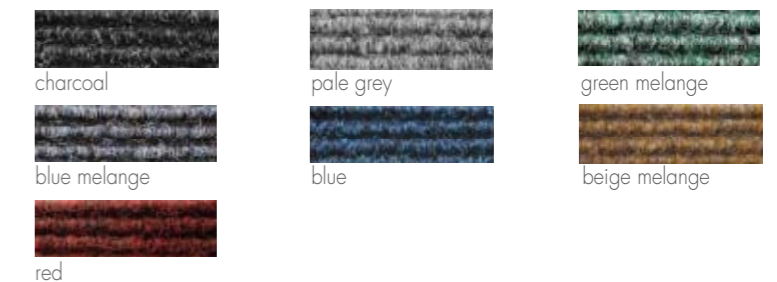

Brush colours for strip height 17 mm



Brush colours for strip height 22 mm

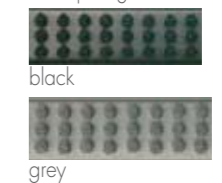

Rubber colour







TOP CLEAN OBJEKT®  
FOR SPECIAL REQUIREMENTS

Doormat especially designed for entrances with antan extra heavy foot traffic, such as airports, railway stations, shopping centres, etc. Recommended for indoor and covered entrances. The mat could also be crossed by a fork lift or other mechanical means of transport. Sturdy, easy to roll up and clean.

Characteristics

- **Approx. 3 mm thick warp resistant aluminium strip**
- **Connecting of the elements: steel flex with PVC sheath**  
Fixing: inserts and screws (AISI 316)
- **Underside of doormat: the rubber strips make walking on the doormat quieter**
- **Ribbed carpet: 100% UV resistant polypropylene**
- **R11 anti-slip characteristics according to DIN 51130 standards**
- **Strip height: 22 mm, 27 mm and 42 mm**
- **Distance between strips: 5 mm (rubber spacer)**
- **Dimensions: Tailor made to any measure required. In width (length of strips) and depth (walking direction) without shimming strip. Cut-outs, angled or circular shaping can be performed to sketch or template, at a surcharge.**
- **On request: powder coated aluminium strip in wide RAL colour range**

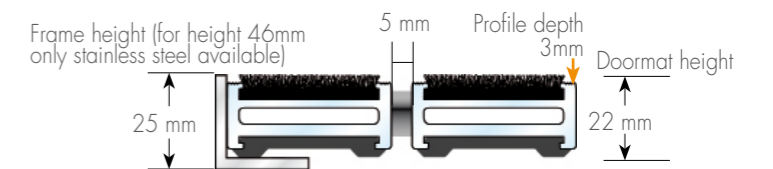
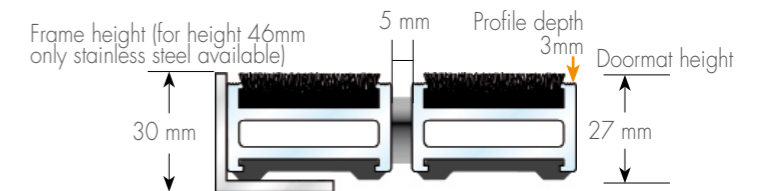
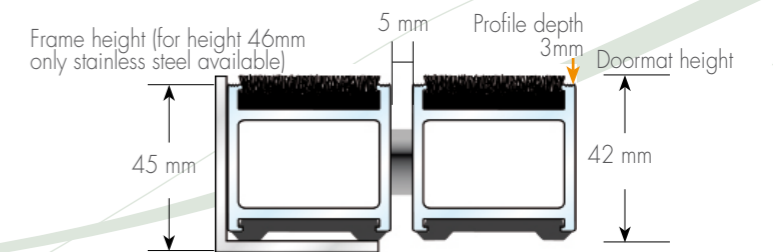

Ribbed carpet colours

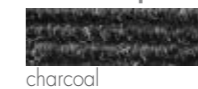





## OUTDOOR ENTRANCE DOORMATS

Gridiron outdoor doormats, the ideal solution for areas with heavy traffic of people wearing sports shoes. Resistant and robust doormats that retain dirt (rocks and dust) and moisture well. The variety and high quality of the materials means that we can fulfil the widest range of functional and aesthetic requests, making all entrances attractive. Resistant to atmospheric agents and corrosion, they guarantee maximum shoe cleaning and are ideal for sports facilities with winter and summer sports activities. Each product comes supplied with a kit of accessories for its easy and immediate fitting.

- **TOP CLEAN TREND® - DOORMATS WITH BRUSH STRIPS**
- **TOP CLEAN TREND® - DOORMATS WITH RUBBER AND BRUSH STRIPS**
- **TOP CLEAN BRUSH - DOORMATS WITH ONLY BRUSH STRIP**

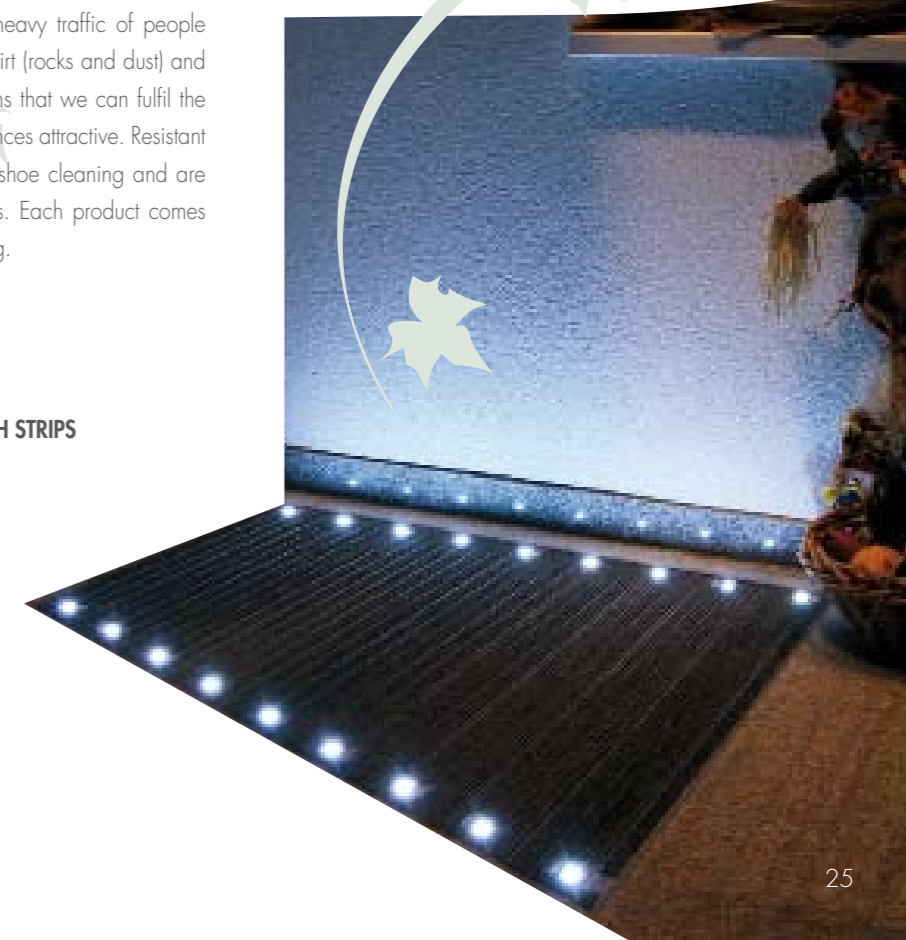





**TOP CLEAN TREND®**  
DOORMAT WITH CASSETTE BRUSHES STRIPS

Doormat ideal for outdoor areas. Resists weathering and corrosion. Maximum cleaning power, particularly suited to entrances subject to wear by sports shoes (in ski resorts and sports centres). Also suitable for entrances with very high levels of transit. Easy to roll up and clean.

**Characteristics**

- Aluminium non-twisting strip (1.5 mm thick)
- Connecting of the elements: steel flex with PVC sheath. Fixing: aluminium inserts with screws (AISI 316)
- Tough brush strips in nylon 6.6 inserted in non-twisting aluminium strip
- Underside of doormat: the rubber strips make walking on the doormat quieter
- Strip height: 17, 22 and 27 mm
- Distance between strips for 17, 22 and 27 mm: 4 and 8 mm (rubber spacer)
- Distance between strips for 13 mm: 4 mm only (rubber spacer)
- Tailor made to any measure required. In width (length of strips) and depth (walking direction) without shimming strip. Cut-outs, angled or circular shaping can be performed to sketch or template, at a surcharge.
- On request: powder coated aluminium strip in wide RAL colour range

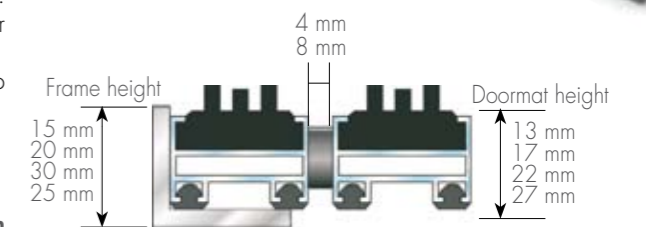

**Brush strip colours**  
for cassette height 13, 17 mm



**Brush strip colours**  
for cassette height 22, 27 mm

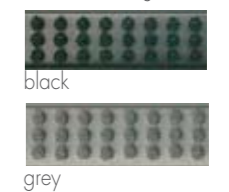



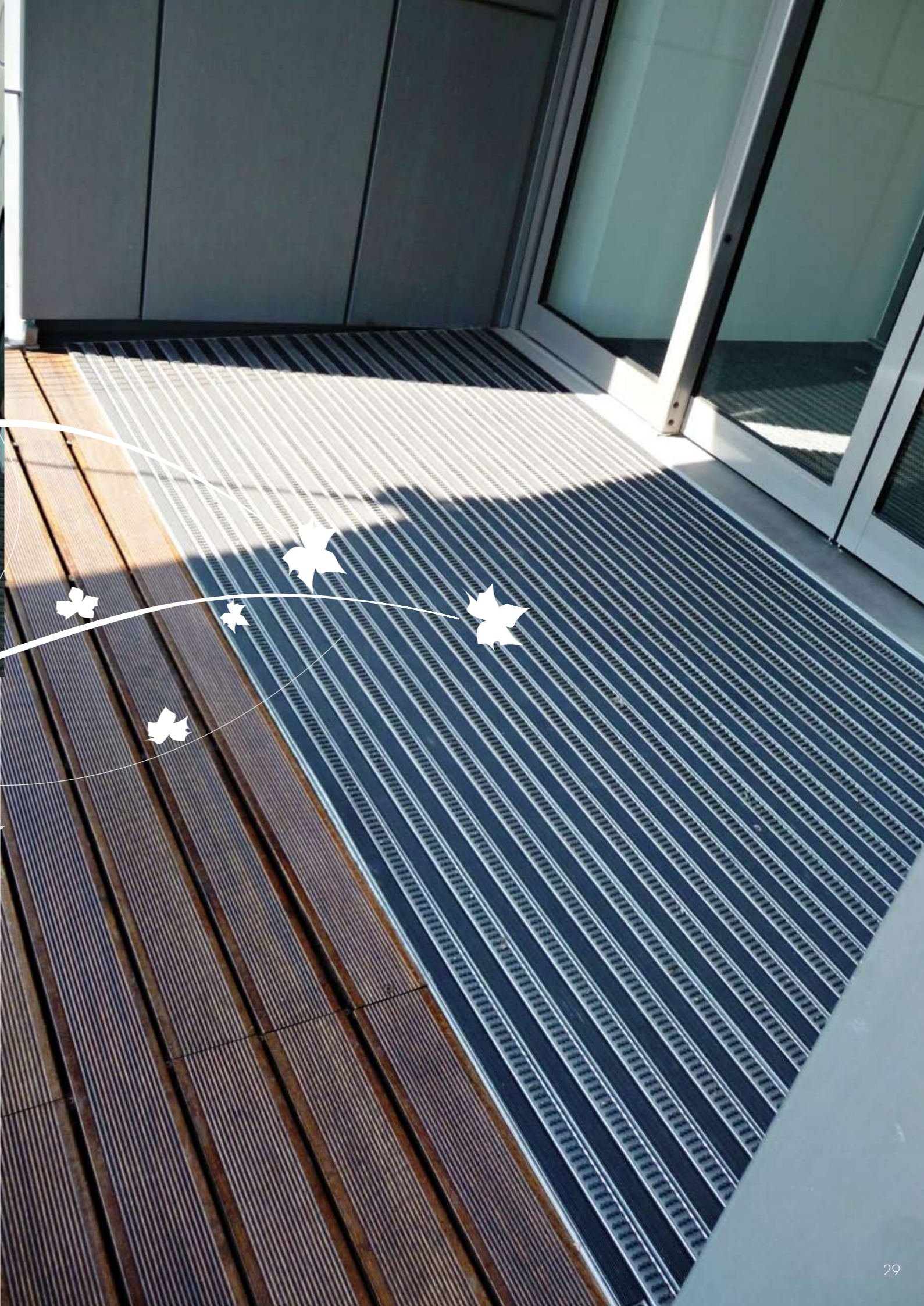
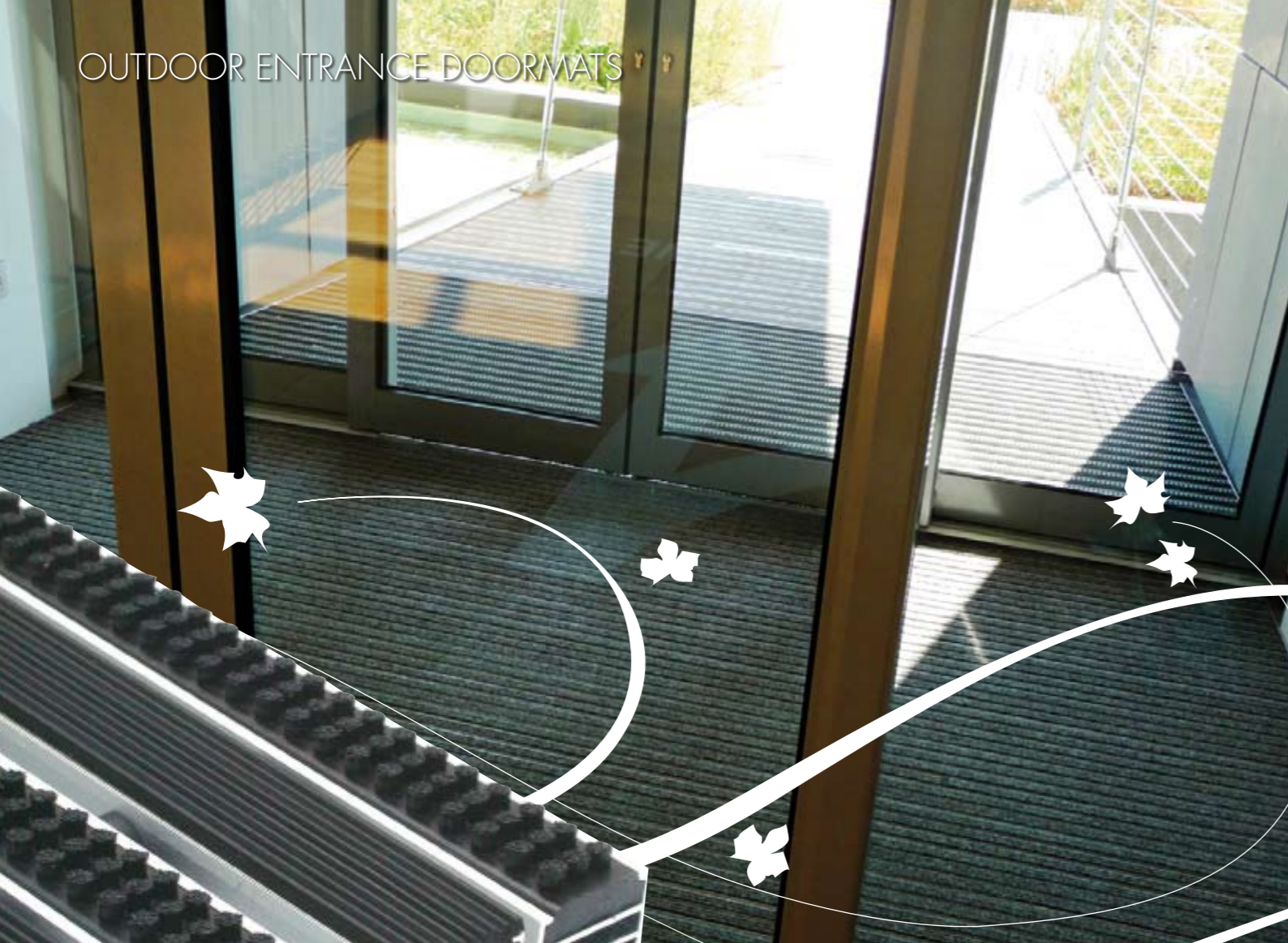

**TOP CLEAN TREND®**  
DOORMAT WITH RUBBER AND CASSETTE  
BRUSHES STRIPS

A doormat resistant to weathering and corrosion, ideal for outdoors. Holds the dirt and absorbs moisture. Alternating rubber and brush strips ensures effective cleaning in the entrance area. The brush strip has an exceptional ability to remove small stones and fine sand from the soles of shoes. Also suitable for entrances with heavy levels of traffic. Easy to roll up and clean.

**Characteristics**

- Aluminium non-twisting strip (1.5 mm thick)
- Connecting of the elements: steel flex with PVC sheath. Fixing: aluminium inserts with screws (AISI 316)
- Rubber strip: ribbed lengthwise, very strong, and EDPM rubber strip resistant to UV light as per DIN 7836 standards.
- Tough brush strips in nylon 6.6 inserted in non-twisting aluminium strip
- Underside of doormat: the rubber strips make walking on the doormat quieter
- Strip height: 17, 22 and 27 mm
- Distance between strips for 17, 22 and 27 mm: 4 and 8 mm (rubber spacer)
- Distance between strips for 13 mm: 4 mm only (rubber spacer)
- Dimensions: Tailor made to any measure required. In width (length of strips) and depth (walking direction) without shimming strip. Cut-outs, angled or circular shaping can be performed to sketch or template, at a surcharge.
- On request: powder coated aluminium strip in wide RAL colour range

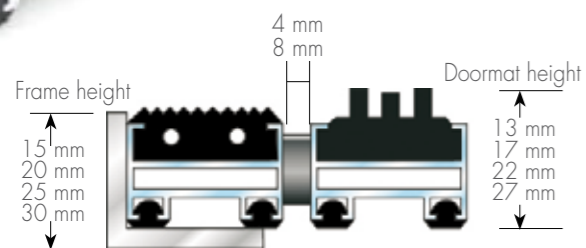

**Brush strip colours**  
for cassette height 13, 17 mm



black



grey

**Brush strip colours**  
for cassette height 22, 27 mm



black



grey

**Rubber strip colour**  
for cassette height 17, 22, 27 mm



black



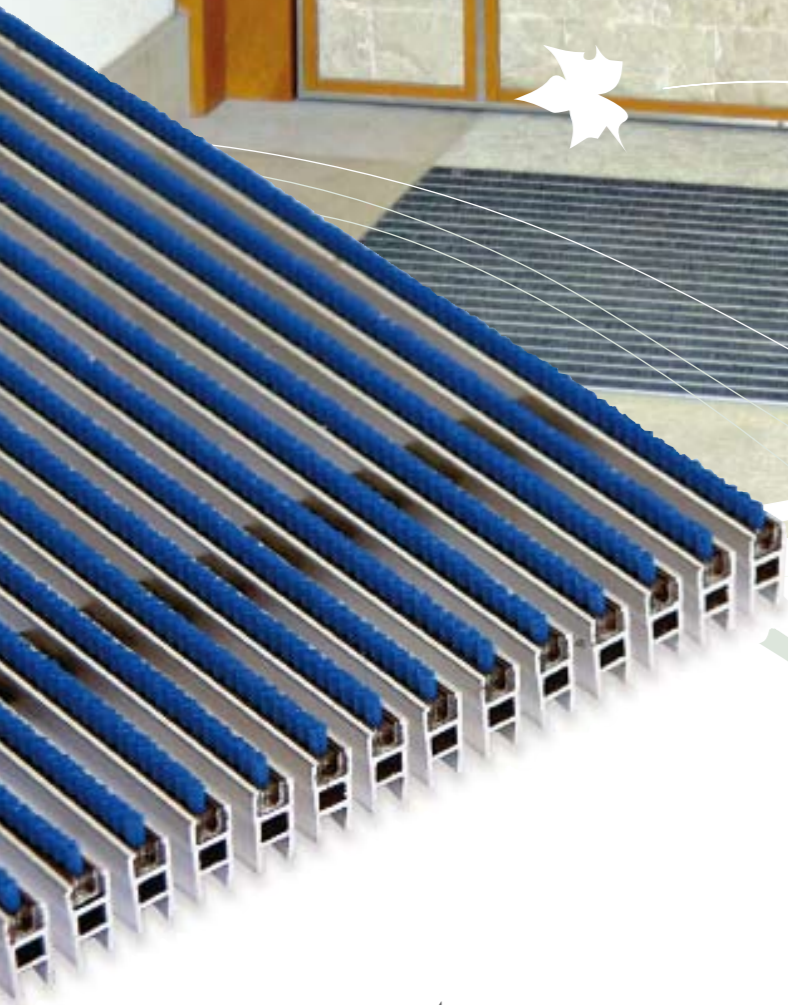

**TOP CLEAN BRUSH**  
IN-BETWEEN BRUSHES

Doormat ideal for outdoor areas. Resists weathering and corrosion. Maximum cleaning power, particularly suited to entrances subject to wear by sports shoes (ski areas and sports centres). Suitable for entrances with normal and frequent levels of transit. Easy to roll up and clean.

**Characteristics**

- Aluminium non-twisting strip (approx. 1 mm thick)
- Connecting of the elements: steel flex with PVC sheath. Fixing: aluminium inserts with screws (AISI 316)
- In between brushes in tough nylon 6.6 inserted in non-twisting aluminium strip
- Strip height: 17mm and approx. 22 mm
- Distance between strips: 4 mm (rubber spacer)
- Dimensions: Tailor made to any measure required. In width (length of strips) and depth (walking direction) without shimming strip. Cut-outs, angled or circular shaping can be performed to sketch or template, at a surcharge.
- On request: powder coated aluminium strip in wide RAL colour range

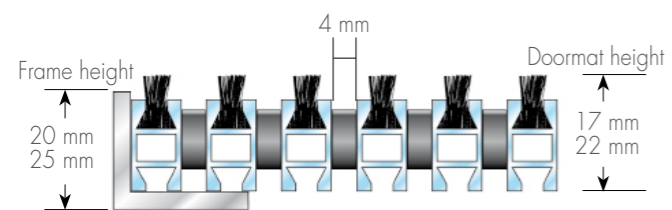

**Brush strips colours**



black



grey



blue

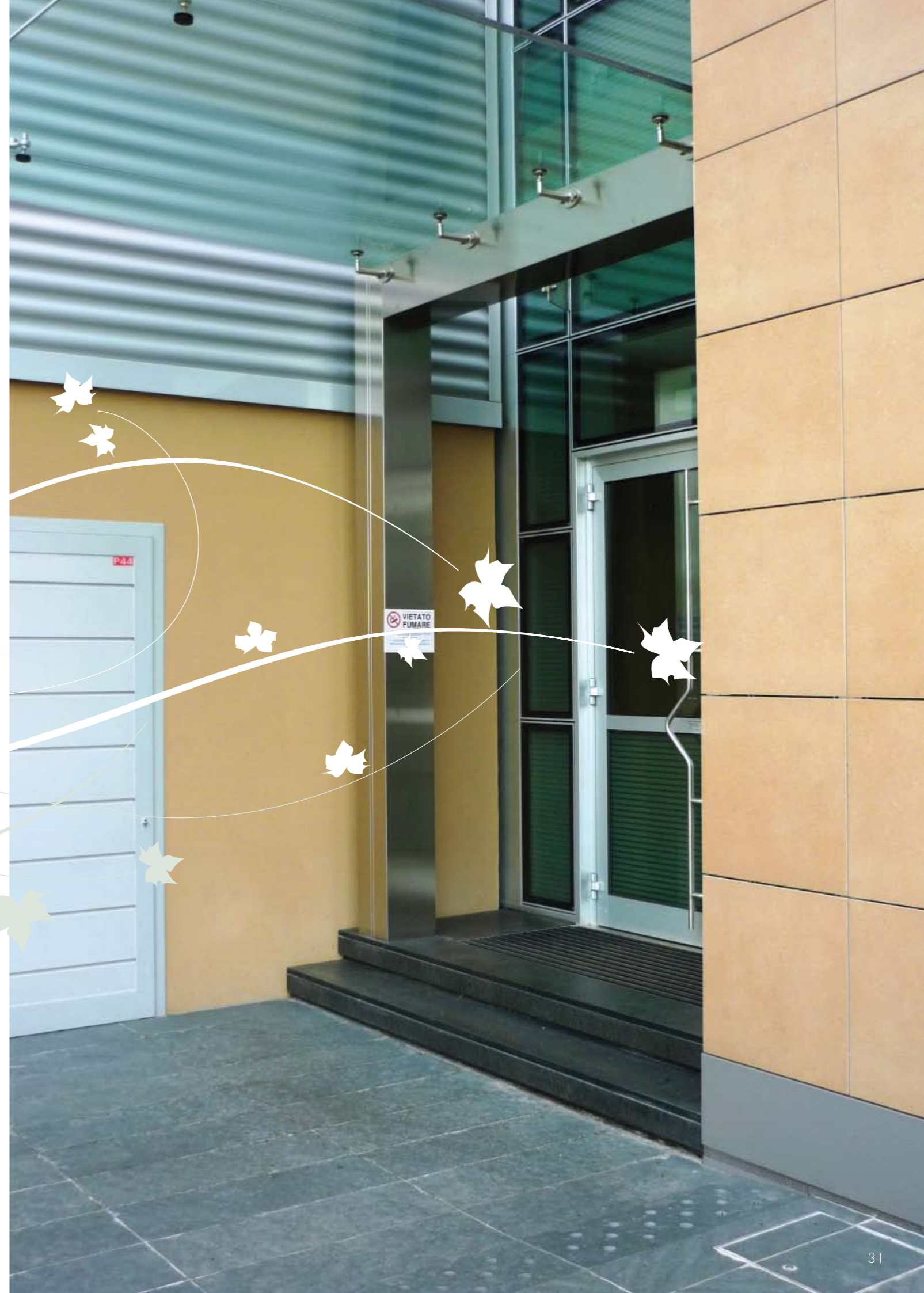



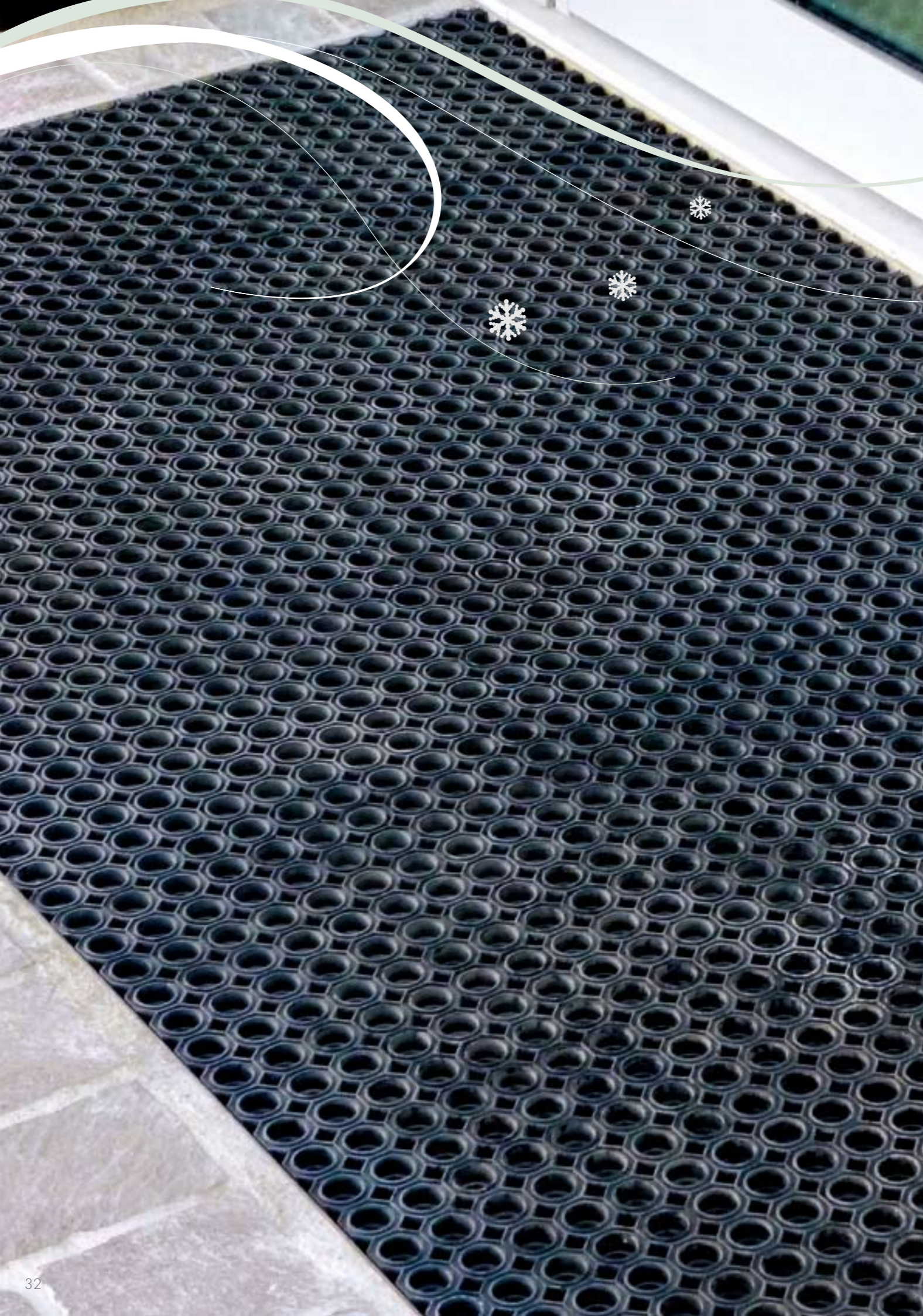

## RUBBER ENTRANCE DOORMATS

Gridiron rubber entrance doormats, the most economical solution guaranteeing cleanliness and duration. In anti-slip rubber, they are ideal for entrances where there is often water and ice, for example at skiing and ice-skating facilities. The high quality of the materials means that we can fulfil the widest range of requests, both for residential and industrial applications. Easy and simple to take care of, they have range of accessories for their customisation, such as the creation of logos or text. Each product comes supplied with a kit of accessories for its easy and immediate fitting.

- KARO AS® - DOORMATS IN RUBBER HONEYCOMB
- DOMINO® - DOORMATS IN RUBBER HONEYCOMB
- WALKING - DOORMATS IN RUBBER HONEYCOMB
- SAFETY CROSS - RUBBER MATS FOR STAIRS
- ACCESSORIES





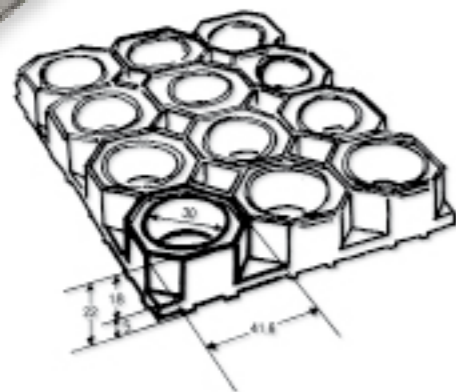
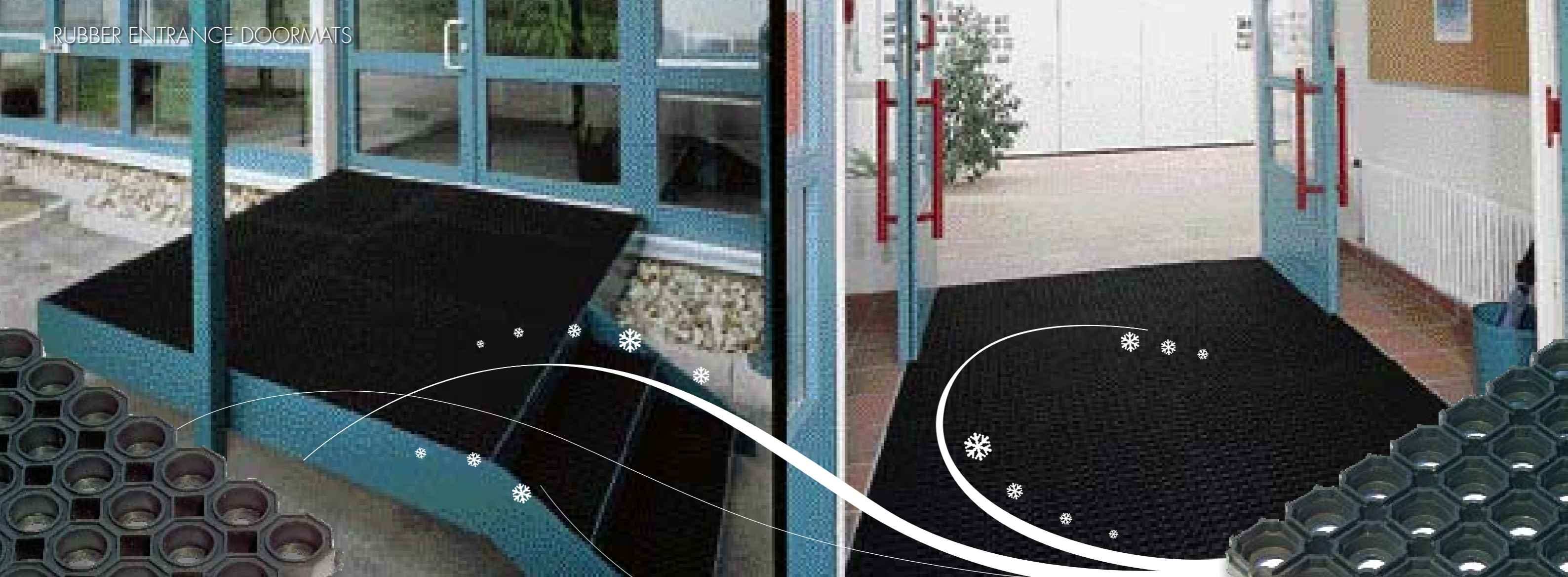

**KARO AS®**  
DOORMAT IN RUBBER HONEYCOMB

**Material:** solid rubber, resistant to scratching and weather  
**Surface:** honeycomb  
**Underside:** 3 mm bumps (for draining the water)  
**Height:** 22 mm  
**Colour:** black  
**Base:** closed, open

- Characteristics**
- High cleaning power, tough and easy to clean
  - Particularly recommended for snowy and rainy areas

- Custom production**
- in any size wanted
  - glued in several parts
  - in triangular, trapezium or round shape

**Round brushes:** see detailed description in the accessories

**Connecting elements:** in rubber, only for doormats with open underside

**Important:** when ordering, always give the final dimension of the doormats!

**Upon request:** Karo As® fire-resistant doormat according to EN 13 501-1 class Cfl - s1

STANDARD SIZES		
Nominal size in cm	Finished panel size in cm	Approx. weight kg
60x40	58,5x38,5	3,0
80x50	78,5x48,5	4,9
90x60	88,5x58,5	7,3
100x50	98,5x48,5	7,3
100x60	98,5x58,5	8,2
120x60	118,5x58,5	9,9
BASIC FORMATS		
119x99	119x98,5	14,9
150x100	150x100	19,0

**DOMINO®**  
DOORMAT IN RUBBER HONEYCOMB

**Material:** solid rubber, resistant to scratching and weather  
**Surface:** honeycomb  
**Underside:** 3 mm bumps (for draining the water) only for height 22 mm  
**Height:** 18 or 22 mm  
**Colour:** black  
**Base:** closed, open

- Characteristics**
- High cleaning power, tough and easy to clean
  - Particularly recommended for snowy and rainy areas

- Custom production**
- in any size wanted
  - glued in several parts
  - in triangular, trapezium or round shape

**Round brushes:** see detailed description in the accessories

**Connecting elements:** in rubber, only for doormats with open underside

**Important:** when ordering, always give the final dimension of the doormats!

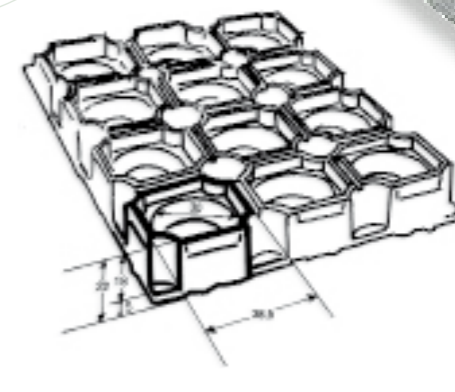

STANDARD SIZES	
Nominal size/Finished panel size in cm	Approx. weight kg
78x59	4,9
100x50	5,4
118x78	10,1
150x100	18,0
BASIC FORMATS	
118x78	10,1
150x100	18,0



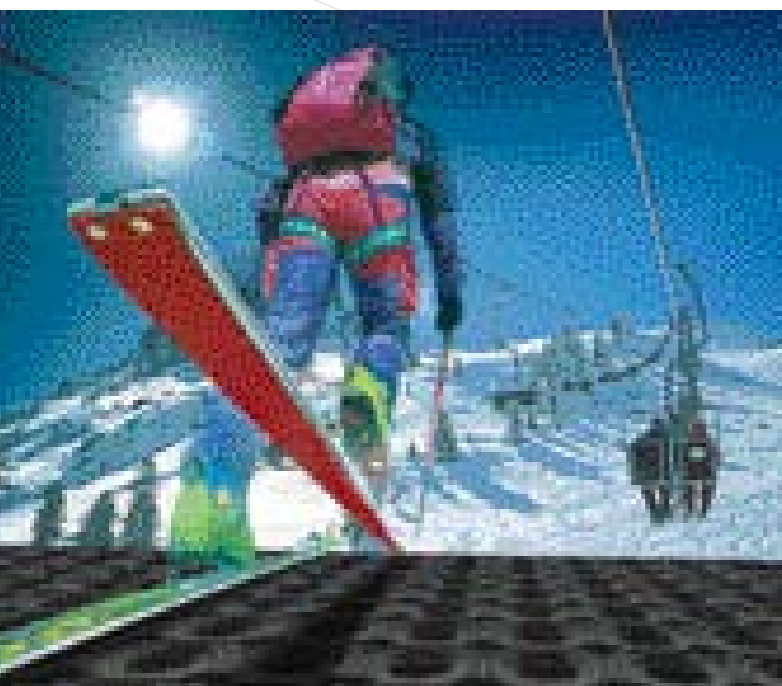

**ECONOMIC**  
THE DOORMAT FOR SNOW

**Material:** solid rubber, resistant to scratching and weather  
**Surface:** honeycomb  
**Underside:** approx. 5 mm bumps (for draining the water)  
**Height:** 22 mm  
**Colour:** black  
**Size:** 150 x 100 cm  
**Base:** open, hole diameter approx. 25 mm  
**Weight:** approx 17.5 kg each  
**Special sizes:** on request

**Characteristics**

- Recommended for ski-lifts and ski resorts generally
- The holes sized approx. Ø 25 mm mean that snow can collect, a problem overcome by the bumps beneath which ensure proper drainage of the water without any problem.

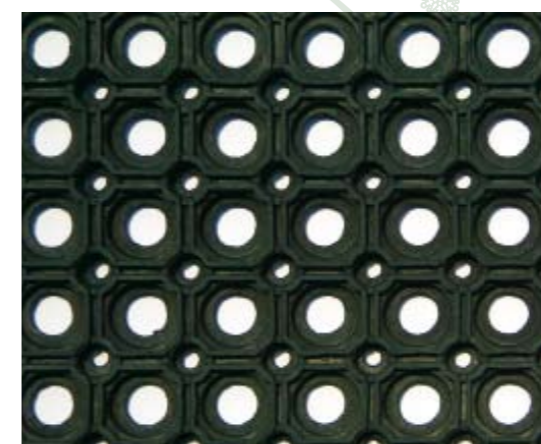

**STANDARD**  
DOORMAT IN RUBBER HONEYCOMB

**Material:** solid rubber, resistant to scratching and weather  
**Surface:** honeycomb  
**Underside:** approx. 5mm bumps (for draining the water)  
**Height of strips:** 22 mm  
**Colour:** black  
**Base:** open  
**Special sizes:** on request

**Characteristics**

Mix of softer rubber than found in Domino. Particularly suitable for snowy and rainy areas.

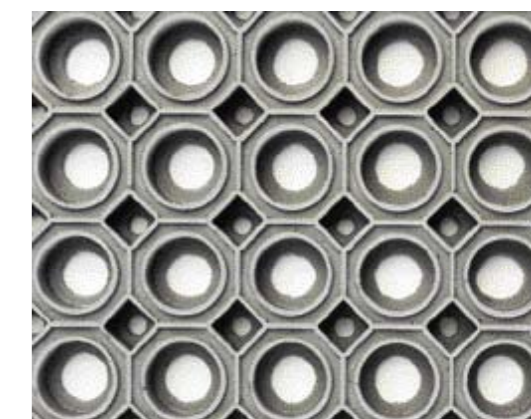

**KARO AS EXTRA**  
DOORMAT IN RUBBER HONEYCOMB

For technical description, see the KARO AS specification sheet.  
**Colour:** grey (can be altered by exposure to UV light)  
**Size:** only available in size 150x100 cm, open underside.  
 Not resistant to acids and oil.  
**Special sizes:** on request  
**Weight:** approx. 20 kg each





**SAFETY CROSS**  
MAT FOR STAIRS

The SAFETY CROSS mat for stairs has a non-slip surface. It can be used both indoors and out. The performed shape protects the stairs. There is self-adhesive tape on the underside of the stair mat (attention: the stairs must be absolutely clean and free of dust).

**Important:** not suitable for stairs in pale natural stone!

**Material:** solid rubber  
**Surface:** "safety-cross" profile  
**Underside:** smooth / 1 adhesive tape  
**Mat depth:** approx. 6.5 mm  
**Size:** 75 x 25 cm  
**Weight:** about 1 kg each

Rubber Colours



black

grey

brown

**EASYCLEAN**  
ROUND BRUSHES

The round brushes can be manually inserted in the honeycomb rubber mats KARO AS or DOMINO without the need for special tools. When required, the round brushes can be easily fitted and replaced. Using the various colours available, personalised patterns can be created (also logos and text).

**Material:** the body of the brush is plastic, while the bristles are in nylon 6.6.  
**Colours:** black, red, green, brown, yellow, blue or grey  
**Quantity:** For rubber honeycomb mats such as Karo As, approx. 265 brushes per m<sup>2</sup>.  
 For rubber honeycomb mats such as Domino (height 22 mm), approx. 313 brushes per m<sup>2</sup>.



**CONNECT**  
RUBBER COUPLINGS

The special rubber couplings are for connecting together KARO AS mats or DOMINO mats in order to make larger sizes. These can be easily inserted by hand and just as easily removed.

**Material:** black rubber





# INGRESSO



## COUPLING ELEMENTS FOR DOORMATS with aluminium profile Top Clean Trend

Doormats longer than 3 metres and/or weighing over 60 kg should be split into multiple pieces, otherwise they become difficult to handle and too heavy both for fitting and for cleaning. To join the pieces there are aluminium couplings which can be fitted either horizontally or vertically. The optical effect is perfect since the joints cannot be seen.

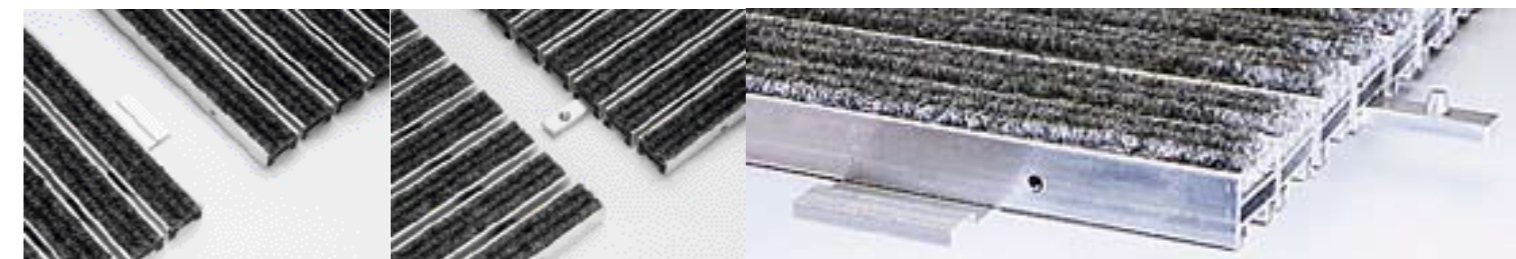
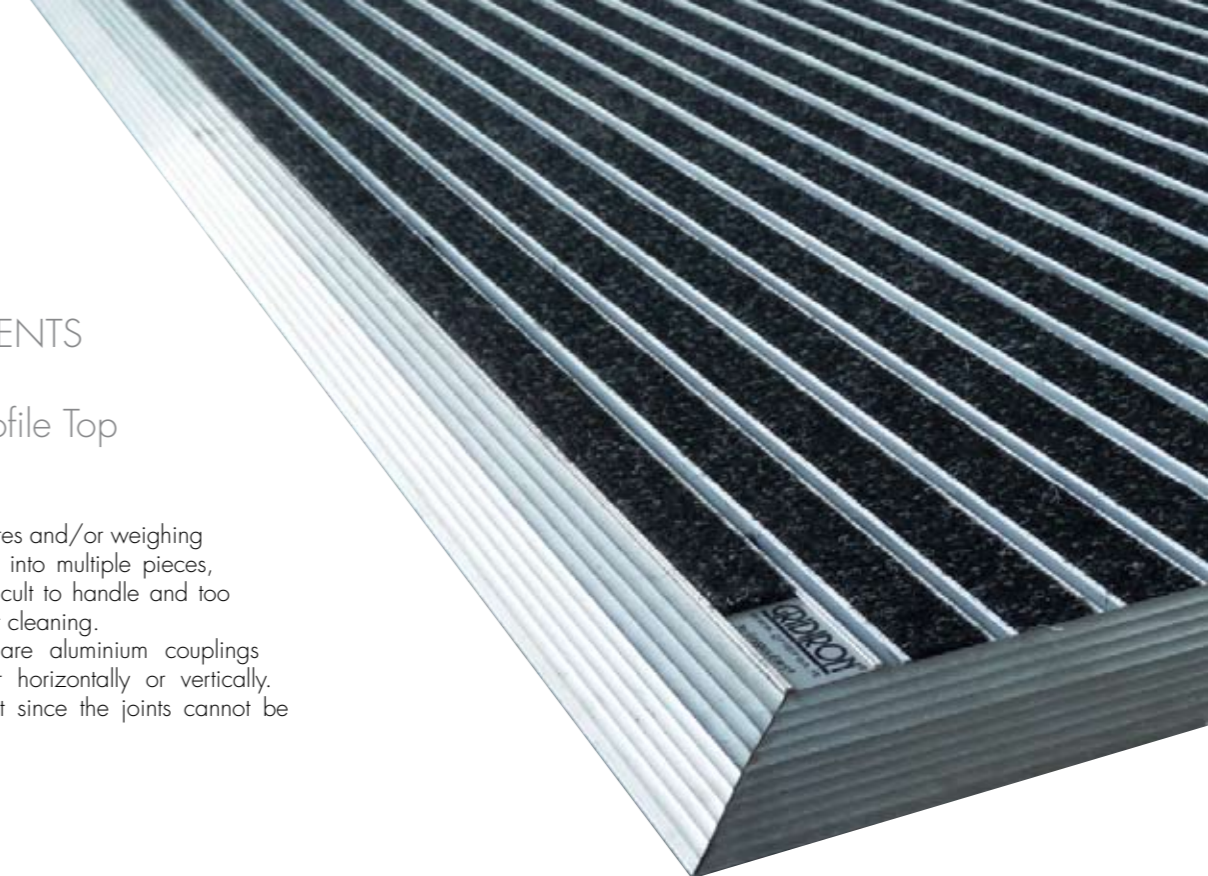

a) Ramp edge height

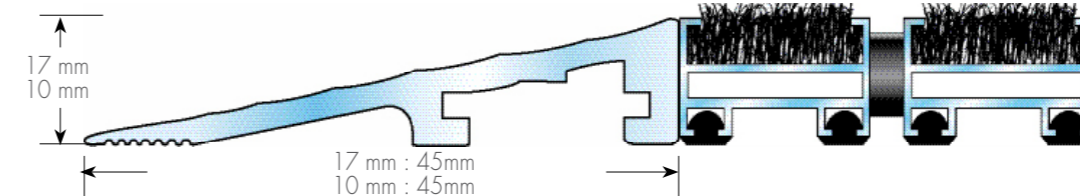

b) For mats height 10 mm the strip is not perforated

RAMP EDGE FOR TOP CLEAN TREND for installation without a frame

The special ramp edge is designed for Top Clean Trend, height 10 and 17 mm. It acts as a frame for the doormat and facilitates a safe passage for pedestrians as well as other wheeled traffic (ex. wheelchairs, baby carriages, etc.).

### Characteristics:

- Aluminium non-twisting serrated strip
- Suitable for Top Clean Trend 10 and 17 mm
- On request: powder coated aluminium strip in wide RAL colour range.

- a) Ramp edge height  
b) For mats height 10 mm the strip is not perforated

### Options for Ramp edge:

- 1) Ramp edge on one-side: the strip is connected to the doormat
- 2) Ramp edge on three sides: the strips are not connected to the doormat, but can be secured to the floor
- 3) Ramp edge on two sides: the strips are connected to the doormat
- 4) Ramp edge on all sides: the strips are not connected to the doormat, but can be secured to the floor

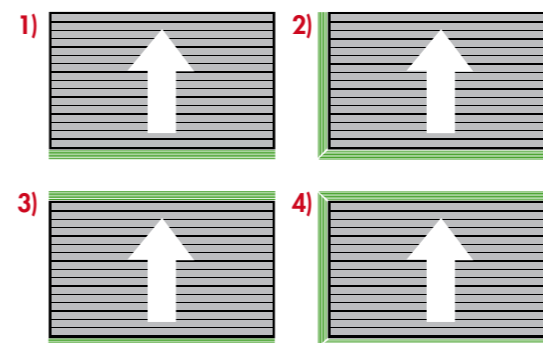



# INSTALLATION ACCESSORIES

## SPECIAL FRAMES

The special frames are recommended for all the Top Clean doormats. These ensure that the doormat fits exactly in the housing and simplify their removal for cleaning. The special frames offer the advantage that the frame, couplings and screws (see photo on left) are in the same material, thus avoiding the risk of corrosion.

### Installing

When installing the special frames, it is necessary to make sure that they are flush with the floor. The floor itself must be perfectly flat to ensure that the doormat lies correctly. Important: when installing the doormat, the right height must be assured!

- The corners are cut at a 45° angle which guarantees the correct locking by the special couplings supplied. To facilitate installation, lugs are placed (photo on left) at a regular distance for strips over 120 cm.
- Attention: the red corner strip – supplied – only acts as a guide (photo on left) to make sure the frame is installed correctly. Only in this way can the installing of the doormat be guaranteed to be free of problems.

### Characteristics:

- Strips in aluminium, brass and stainless steel, 3 mm thick
- Height: 15, 20, 25, 30 and 45 mm
- Cut-outs, angled or circular shaping can be performed to sketch or template, at a surcharge.
- On request: powder coated aluminium strips in wide RAL colour range



## FRAME SIZES

Special frames (cut at 45° angle and fastened by special couplings)

ALUMINIUM AND BRASS FRAMES			FOR DOORMAT HEIGHTS
Height	Width	Thickness mm	mm
15	20	3	10
20	20	3	17
25	25	3	22
30	30	3	27
45*	30*	3*	42*

\* For the aluminium frame only

STAINLESS STEEL FRAMES			FOR DOORMAT HEIGHTS
Height	Width	Thickness mm	mm
15	15	2	10
20	20	3	17
25	25	3	22
30	30	3	27

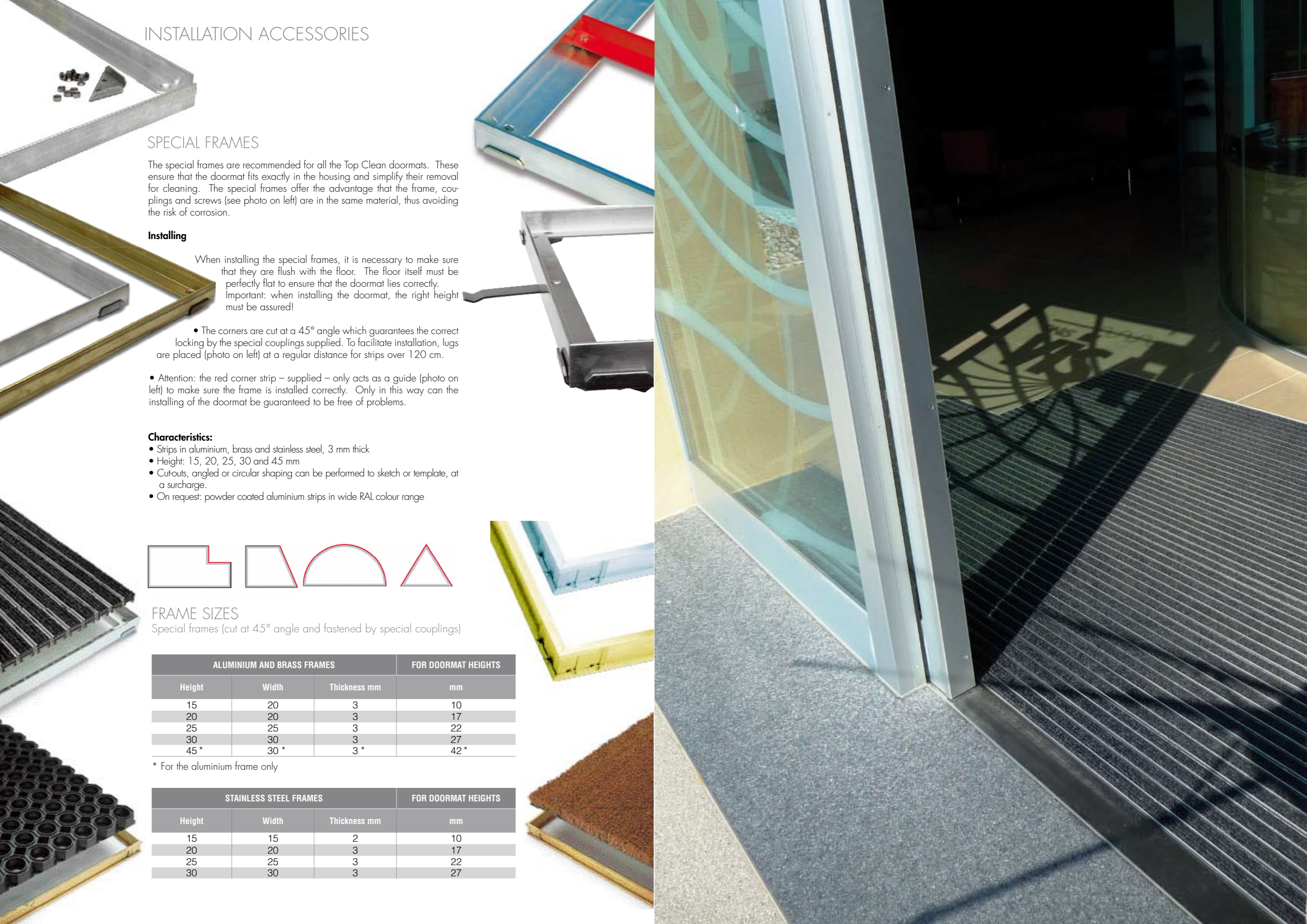



## CLEANING RECOMMENDATIONS

How long Top Clean doormats last depends on their cleaning, which should be done regularly. The dirt falls between the strips and accumulates at the bottom of the doormat. The frequency of cleaning depends on the extent of the dirt.

**a) Fine dirt:** vacuum the surface of the doormat as much as possible and/or roll up and remove the doormat in order to vacuum the dirt accumulated beneath.

**b) Coarse dirt:** after having vacuumed the doormat, roll up and remove it from the frame, and then remove the dirt from the underside of the mat.

**c) Damp dirt:** after points a) and b), clean the doormat also using a high pressure cleaner. The doormat should be stood up so that, after a certain drying time (overnight if possible), the mat can be used once again. A commercially available floor cleaning machine can also be used for cleaning.

**Replacement of the ribbed carpet strips:** cigarette butts, chewing gum and also oil stains are the enemies of doormats. So we have developed a system for replacing dirty or damaged ribbed carpet strips. The support structure remains, and the new ribbed carpet strips are glued on the back and replaced.



## RECOMMENDED PROCEDURE FOR REPLACING RIBBED CARPET STRIPS

**1)**  
Using a screwdriver, release and remove the end piece from the ribbed carpet strip.

**2)**  
Important: remove dirt, the fabric and residual glue from the aluminium strip (using, for instance, a chisel).

**3)**  
Glue the new ribbed carpet strip with self-adhesive tape on the back into the aluminium strip and, if necessary, use a rubber mallet to knock into position.

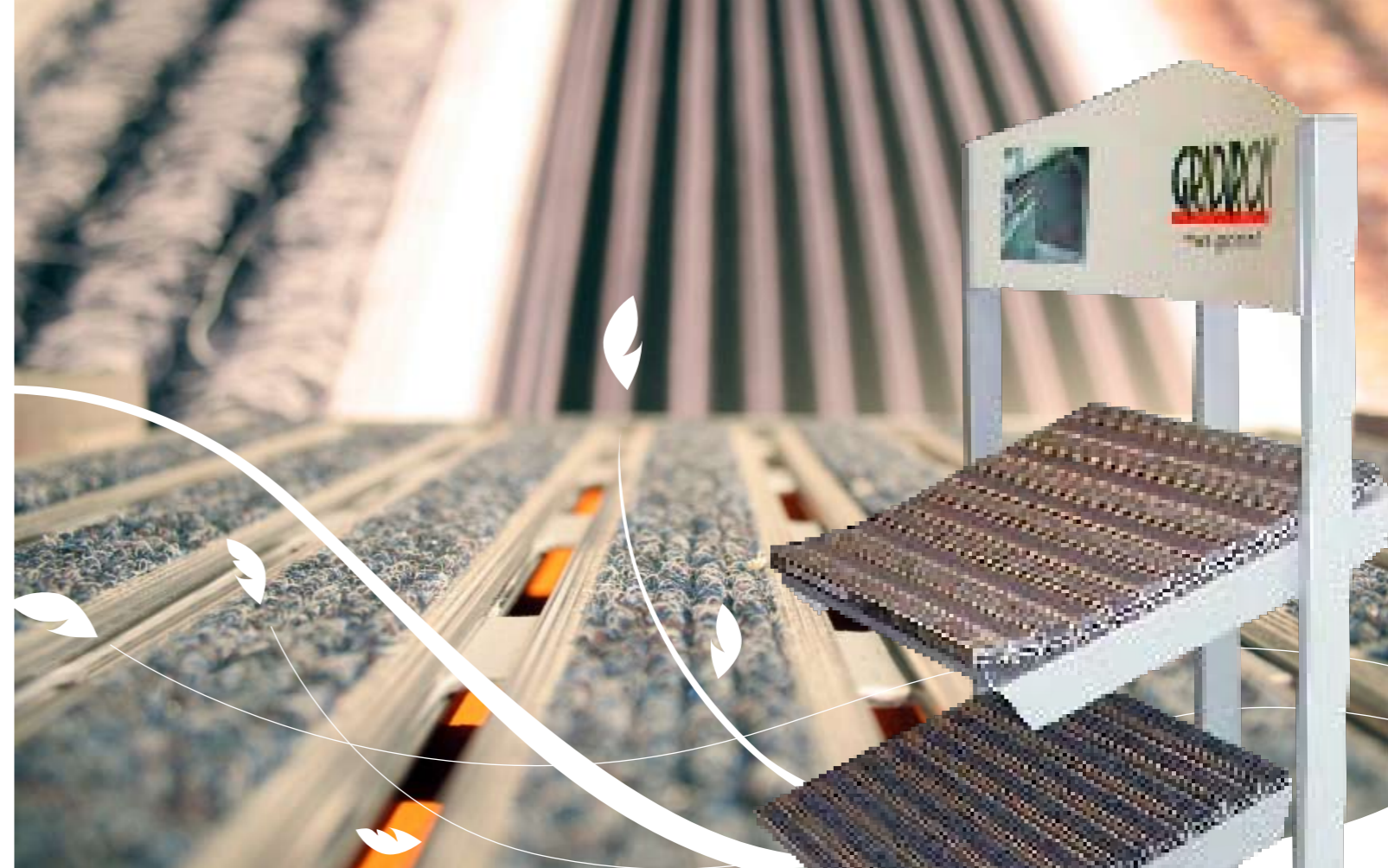

## DISPLAY STAND

The range of Gridiron doormats effectively satisfies all needs: the various solutions offered take into account the location of the doormat and its conditions of use.

For doormat sales points, Gridiron has designed and built a useful floor display stand that holds the various models.

This makes it easy to compare the aesthetic and functional differences and select the best doormat in relation to the type of specific use and the required characteristics: indoor and covered entrances with limited or extra heavy of pedestrian traffic, cleaning easiness, ability to absorb water, necessity to protect valuable floors, etc.

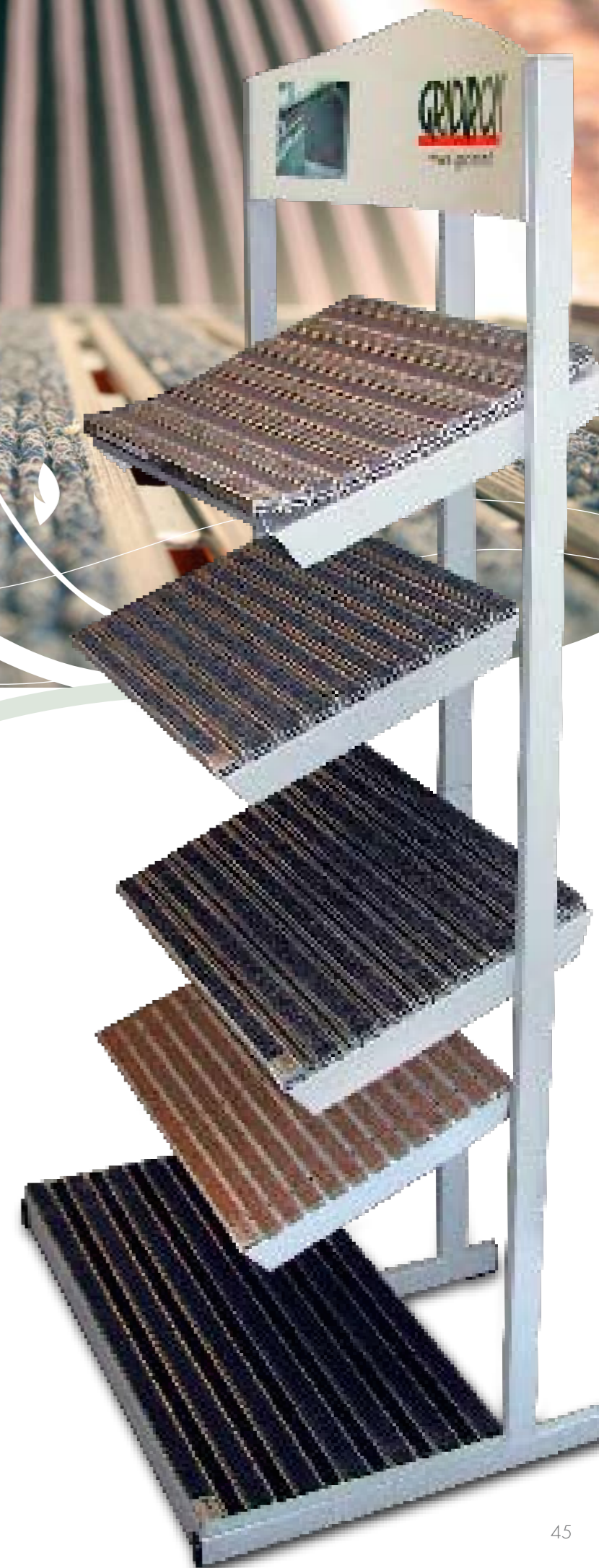





## FINISHES

### Rough ribbed carpet colours for height 13, 17, 22, 27, 42 mm



charcoal

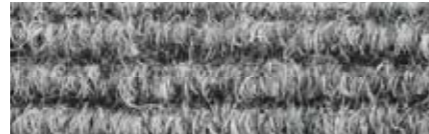

pale grey



green melange



blue melange



blue



beige melange



red\*

\* only for height 17, 22, 27 mm

### Fine ribbed carpet colours for height 10 mm

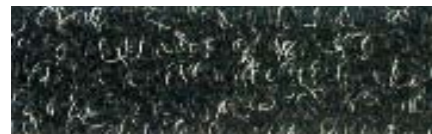

charcoal



pale grey



beige melange



blue melange

### Narrow scraper

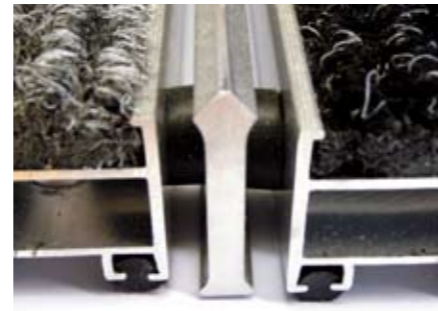

### Brush strip colours for height 13, 17 mm



black



grey

### Brush strip colours for height 22, 27 mm



black



grey

### Rubber strip colour for height 17, 22, 27 mm



black

### In-between brush colours for Brush doormats (see page 30)



black



grey



blue

### Rubber colours for Safety Cross doormats (see page 38)



black



grey



brown







# INDOOR AND OUTDOOR entrance mats

LEVER PLAN

**GRIDIRON**  **GRIDIRON**  
SPECIAL PRODUCTS  
GRIGLIATI TECNICI

31010 Mareno di Piave (TV) Italia  
Via E. Fermi (Z.I. Ramera)  
Tel. +39.0438.492.502 r.a.  
Fax +39.0438.492.545

mail: [info@gridiron.it](mailto:info@gridiron.it)  
[www.gridiron.it](http://www.gridiron.it)

 **GRIDIRON**  
SPECIAL PRODUCTS

**GRIDIRON**  
GRIGLIATI TECNICI